

Q-Line series

48V TRACK PARTS

48V-Q1 SURFACE
MINI TRACK RAIL

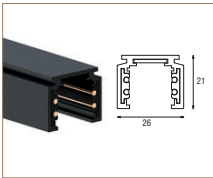

CX-M10-BL 48V-Q1 1000mm black
CX-M10-WH 48V-Q1 1000mm white
CX-M15-BL 48V-Q1 1500mm black
CX-M15-WH 48V-Q1 1500mm white
CX-M20-BL 48V-Q1 2000mm black
CX-M20-WH 48V-Q1 2000mm white

48V-Q2 SURFACE
HIGH TRACK RAIL

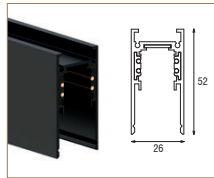

CX-MA10-BL 48V-Q2 1000mm black
CX-MA10-WH 48V-Q2 1000mm white
CX-MA15-BL 48V-Q2 1500mm black
CX-MA15-WH 48V-Q2 1500mm white
CX-MA20-BL 48V-Q2 2000mm black
CX-MA20-WH 48V-Q2 2000mm white

48V-Q2 RECESSED
TRIMLESS HIGH RAIL

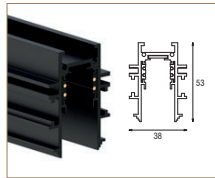

CX-MD10-BL 48V-Q2 1000mm black
CX-MD10-WH 48V-Q2 1000mm white
CX-MD15-BL 48V-Q2 1500mm black
CX-MD15-WH 48V-Q2 1500mm white
CX-MD20-BL 48V-Q2 2000mm black
CX-MD20-WH 48V-Q2 2000mm white

48V-Q2 EMBEDDED
BRACKET

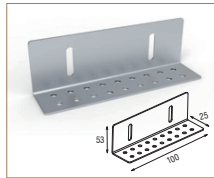

CX-MD24 48V-Q2 for CX-MD10/15/20
 + 2 screws

48V-Q1
SUSPENSION SET

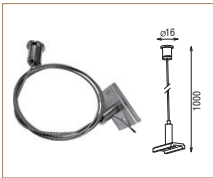

CX-M020 48V-Q1 1m CX-M10/15/20

48V-Q2
SUSPENSION SET

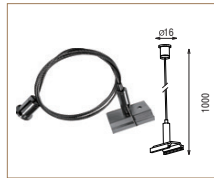

CX-M021 48V-Q2 1m CX-MA10/15/20

48V-Q1 ALUMINIUM
CONNECTION

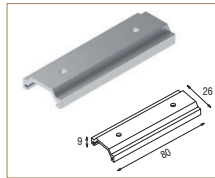

CX-M022 48V-Q1 CX-M10/15/20 mini

48V-Q2 ALUMINIUM
CONNECTION

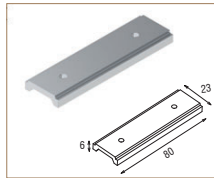

CX-M023 48V-Q2 CX-MA10/15/20

48V-Q1 ENDCAP
HOLE MINI



CX-M025-BL 48V-Q1 for CX-M10/15/20 black
CX-M025-WH 48V-Q1 for CX-M10/15/20 white

48V-Q1 ENDCAP
CLOSED MINI

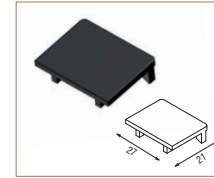

CX-M026-BL 48V-Q1 for CX-M10/15/20 black
CX-M026-WH 48V-Q1 for CX-M10/15/20 white

48V-Q2 ENDCAP
HOLE HIGH

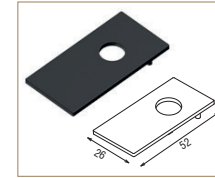

CX-M029-BL 48V-Q2 black
CX-M029-WH 48V-Q2 white

48V-Q2 ENDCAP
CLOSED HIGH

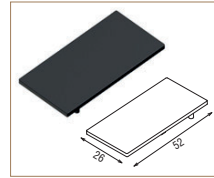

CX-M030-BL 48V-Q2 black
CX-M030-WH 48V-Q2 white

48V-Q1/Q2
END FEED



CX-M031-BL 48V-Q1/Q2 black
CX-M031-WH 48V-Q1/Q2 white

48V-Q1/Q2
STRAIGHT JOINT



CX-M032-BL 48V-Q1/Q2 black
CX-M032-WH 48V-Q1/Q2 white

48V-Q1
CONNECTOR MINI

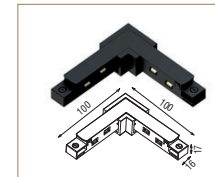

CX-M033-BL 48V-Q1 L mini black
CX-M033-WH 48V-Q1 L mini white

48V-Q2
CONNECTOR HIGH

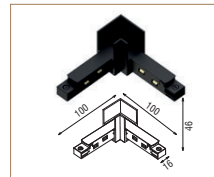

CX-M034-BL 48V-Q2 L high black
CX-M034-WH 48V-Q2 L high white

48V-Q1/Q2 FLEXIBLE
CONNECTOR



CX-M035-BL 48V-Q1/Q2 black
CX-M035-WH 48V-Q1/Q2 white

48V-Q2 ANGLE
CONNECTION BRACKET

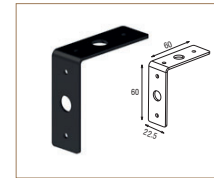

CX-M036 48V-Q2 high black

48V-Q2
CONNECTOR SHEET

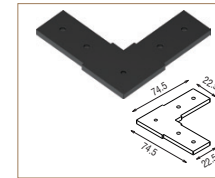

CX-M037-BL 48V-Q2 L high black

INSTALLATION MANUAL

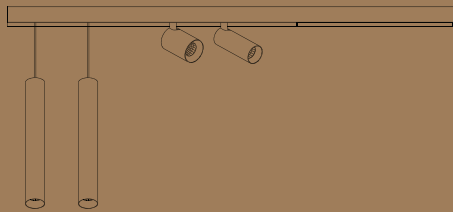

Q-Line series
48V TRACK SYSTEM

CAFE

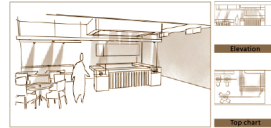

OFFICE



STORE



SHOWROOM



BAR



RECESSED TRACK 48V TRACK SYSTEM

Q2



Turn off the power supply before carrying out any installation, maintenance or re pair work

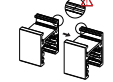
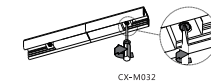
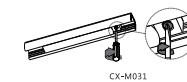
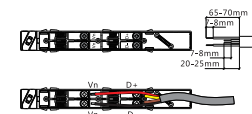
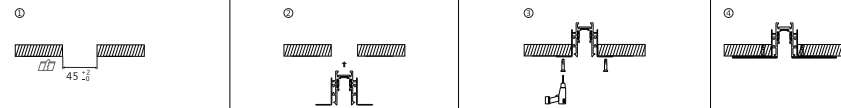
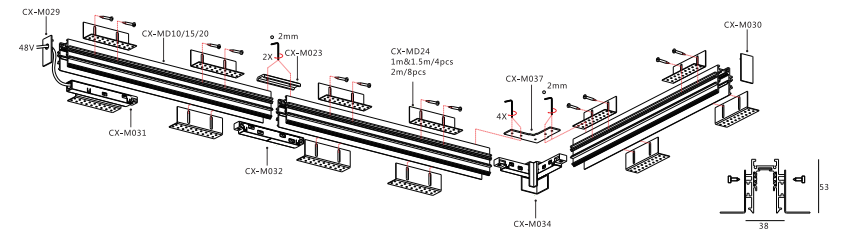

SURFACE TRACK
48V TRACK SYSTEM

Q1

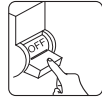

Turn off the power supply before carrying out any installation, maintenance or re pair work

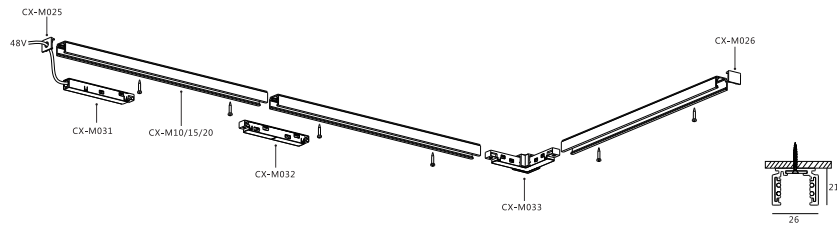

KARIZMA_{luce}

SURFACE TRACK
48V TRACK SYSTEM

Q2



Turn off the power supply before carrying out any installation, maintenance or re pair work

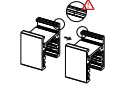
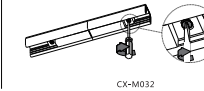
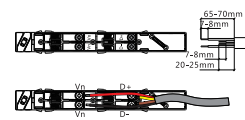
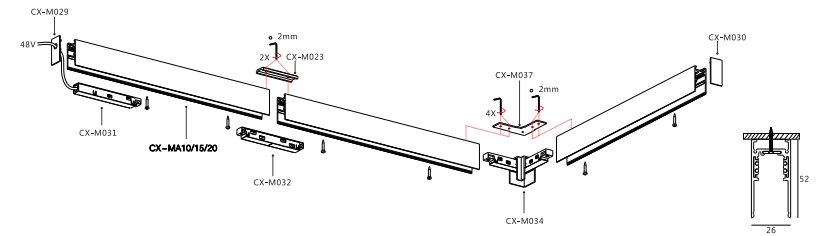

KARIZMA_{luce}

SUSPENDED TRACK
48V TRACK SYSTEM

Q1

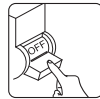

Turn off the power supply before carrying out any installation, maintenance or re pair work

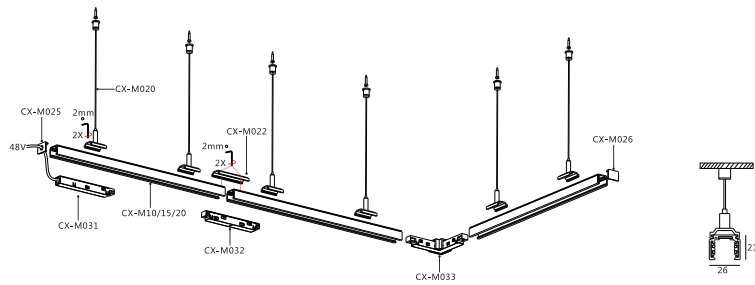

SUSPENDED TRACK
48V TRACK SYSTEM

Q2



Turn off the power supply before carrying out any installation, maintenance or re pair work

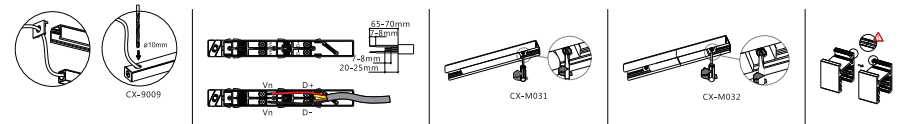
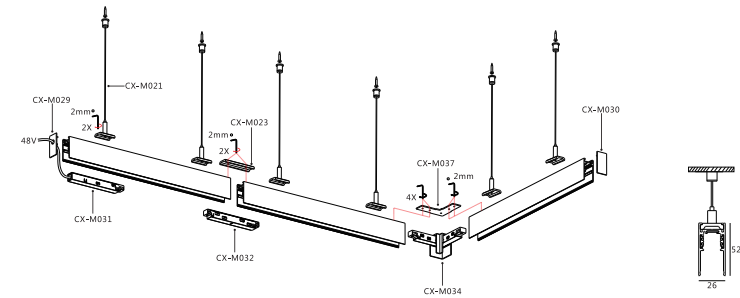

END FEED

48V TRACK SYSTEM



Turn off the power supply before carrying out any installation, maintenance or re pair work

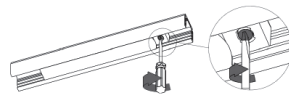
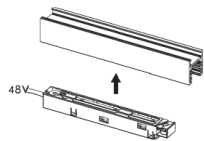
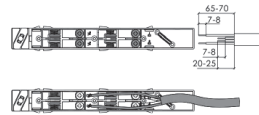
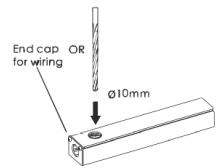
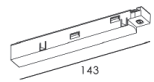

KARIZMA_{luce}

STRAIGHT JOINT

48V TRACK SYSTEM



Turn off the power supply before carrying out any installation, maintenance or re pair work

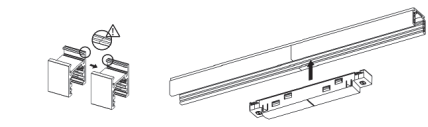
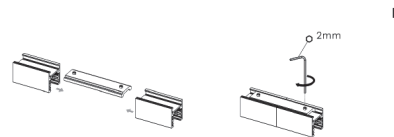
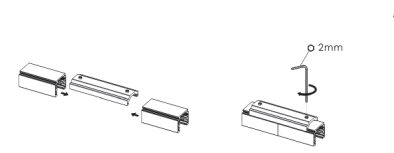

KARIZMA_{luce}

PART A

48V TRACK SYSTEM

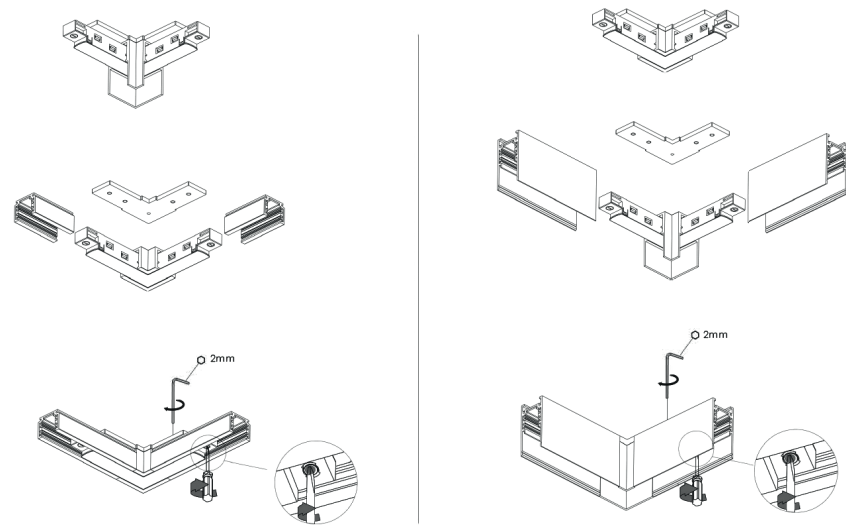

KARIZMA_{luce}

PART B

48V TRACK SYSTEM

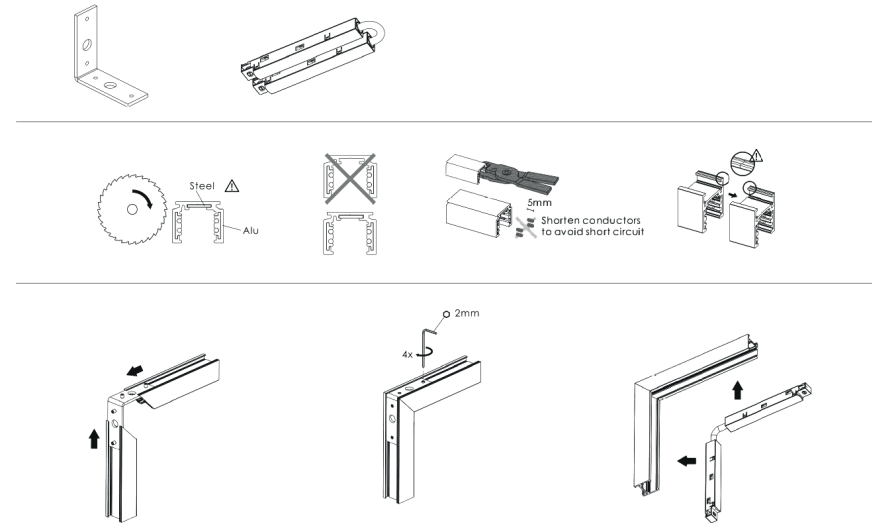

KARIZMA_{luce}

WIRING DIAGRAMS
48V TRACK SYSTEM

On/Off

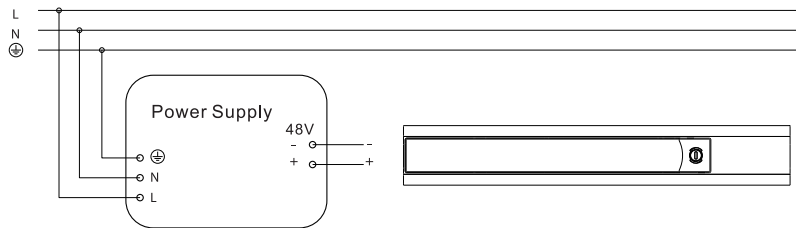

Dali

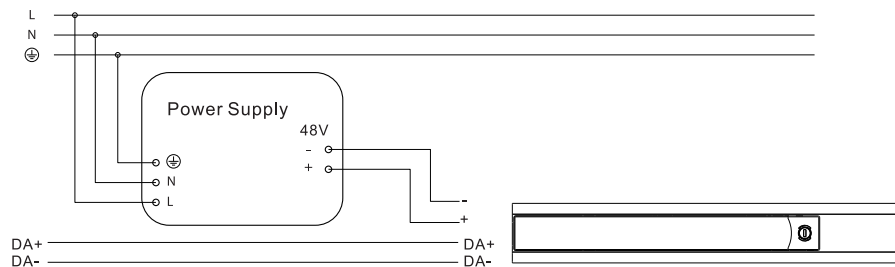

KARIZMA_{luce}

